

Toroidal transformer type 77015

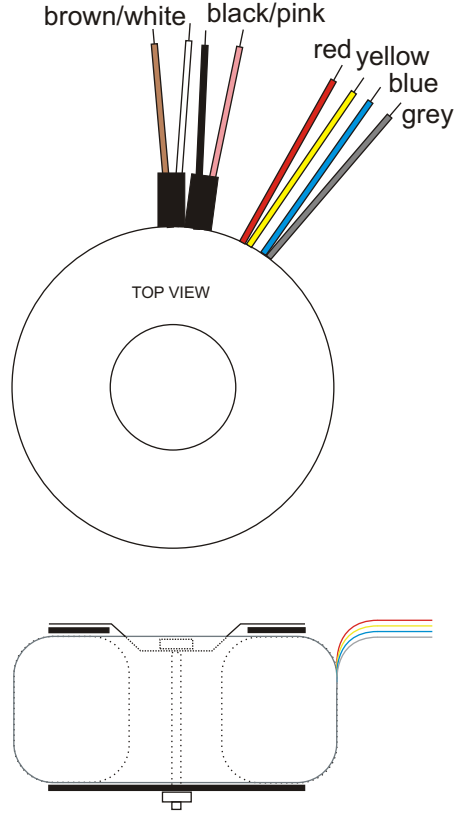
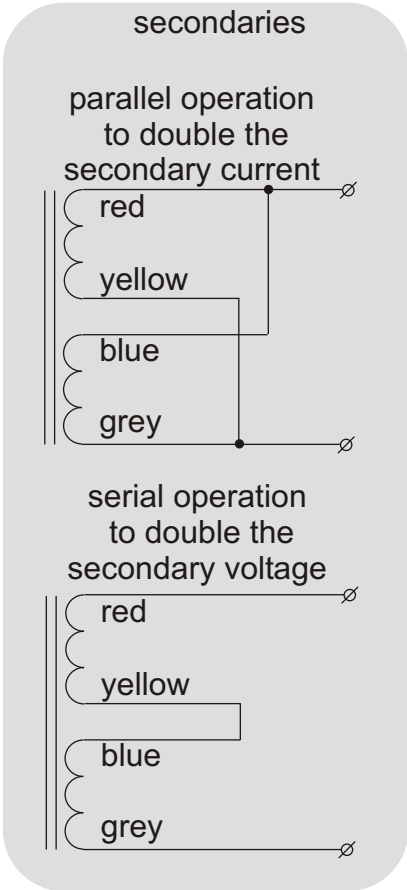
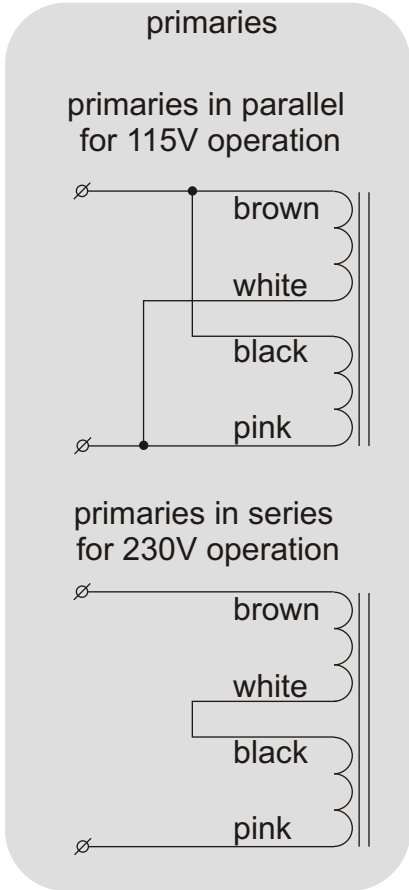
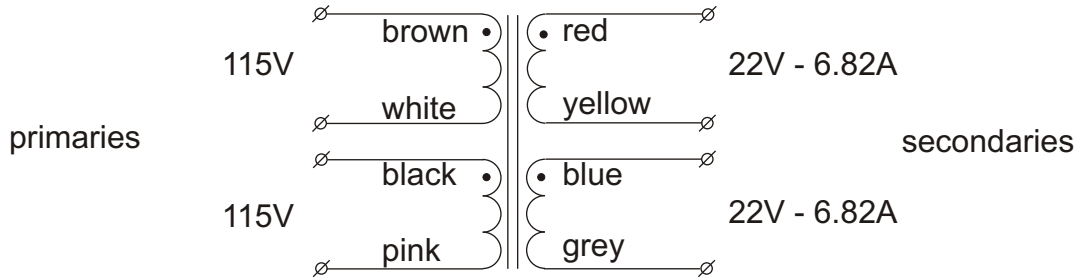

Diameter 121mm
 Height 56mm
 Weight 2.9kg
 Height and weight are measured without mounting materials
 All leads are solid and approx 200mm long

Supplied mounting materials:
 1 metal washer Ø90mm
 2 neoprene washers Ø90mm
 1 bolt M5x70mm with nut

With KEMA KEUR, ENEC, CE and UL/CSA approvals
 KEMA certificate 96 2307, UL filenumber E320377.

Time lag fuses to be used.
 For 230V use: primary: 1.6A, 5x20mm, IEC127, high I²t value
 secondary: none
 For 115V use: primary: 3.15A, 5x20mm, IEC127, high I²t value
 in series with 2 NTC-resistors NTC2.5
 secondary: none

Type number	primary	secondaries voltage	current
77015	2x115V	2x 22V	6.82A

All voltages are under full ohmic load.
 Regulation : 5%

300VA	115V / 230V	50Hz / 60Hz	
	KEMA KEUR	RoHS	
UL US	CCA	CB	CE

	Industrieweg 14 NL-7161BX NEEDE The Netherlands P O - B o x 27 NL-7160AA NEEDE The Netherlands Tel. +31 (0)545 283456 Fax +31 (0)545 283457 info@amplimo.nl http://www.amplimo.nl	HB	Oct 2010	<h2>77015</h2> <p>toroidal transformer 300VA for 115V or 230V operation</p>
	© Copyright Amplimo BV			