

Toroidal transformer type 67070

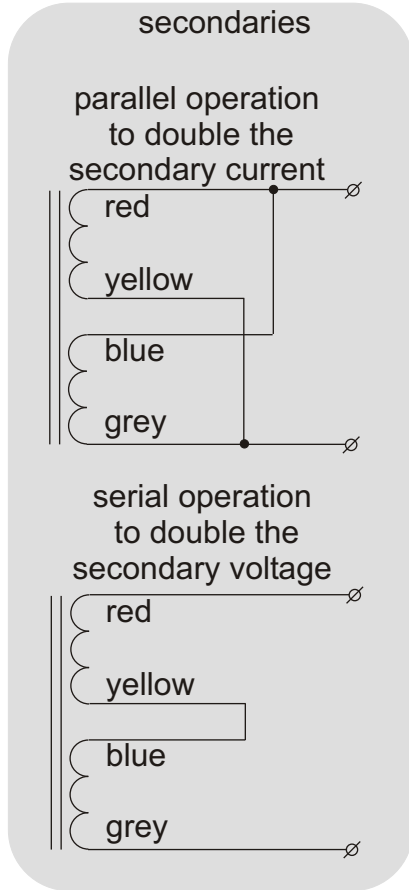
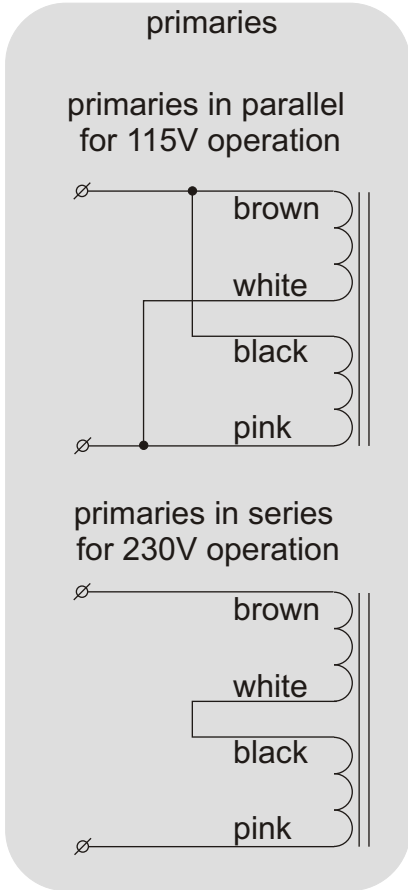
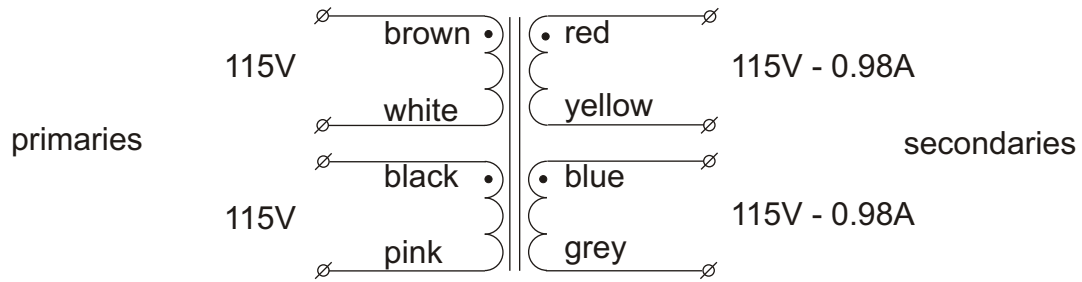

Diameter 110mm
 Height 52mm
 Weight 2.3kg
 Height and weight are measured without mounting materials
 All leads are solid and approx 200mm long

Supplied mounting materials:
 1 metal washer Ø90mm
 2 neoprene washers Ø90mm
 1 bolt M5x60mm with nut

With KEMA KEUR, ENEC, CE and UL/CSA approvals
 KEMA certificate 96 2307, UL filenumber E320377.

Time lag fuses to be used.
 For 230V use: primary: 1.0A, 5x20mm, IEC127, high I²t value
 secondary: none
 For 115V use: primary: 2.0A, 5x20mm, IEC127, high I²t value
 secondary: none

Type number	primary	secondaries voltage	current
67070	2x115V	2x 115V	0.98A

All voltages are under full ohmic load.
 Regulation : 7%

225VA	115V / 230V	50Hz / 60Hz	
	KEMA KEUR	RoHS	
UL US	CCA	CB	CE

	Industrieweg 14 NL-7161BX NEEDE The Netherlands P O - B o x 27 NL-7160AA NEEDE The Netherlands Tel. +31 (0)545 283456 Fax +31 (0)545 283457 info@amplimo.nl http://www.amplimo.nl	HB	Oct 2010	<h2>67070</h2> <p>toroidal transformer 225VA for 115V or 230V operation</p>
	© Copyright Amplimo BV			