

### Toroidal transformer type 47010

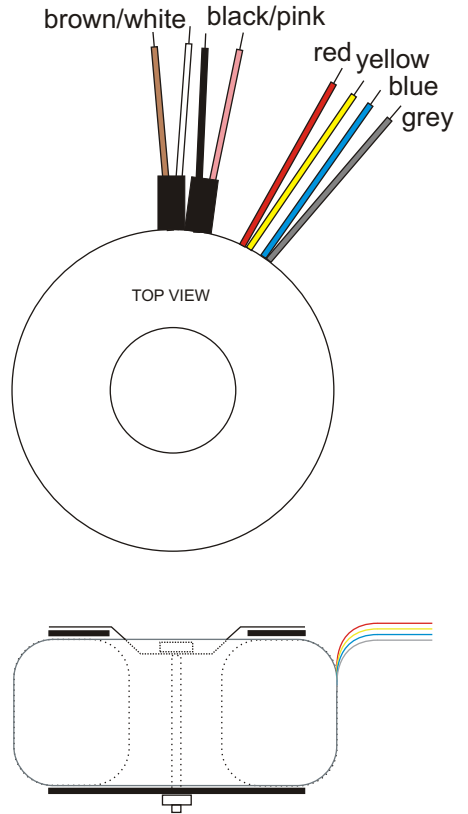
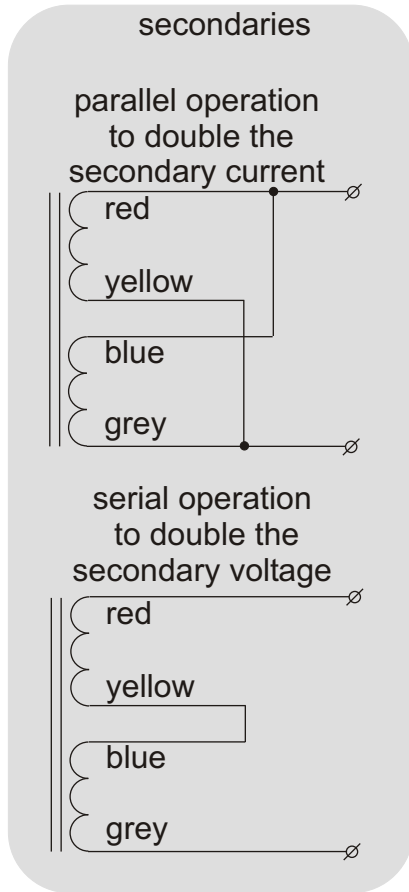
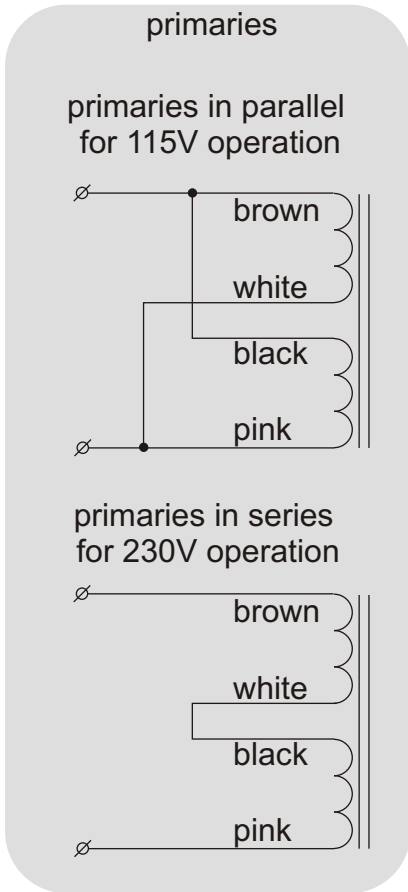
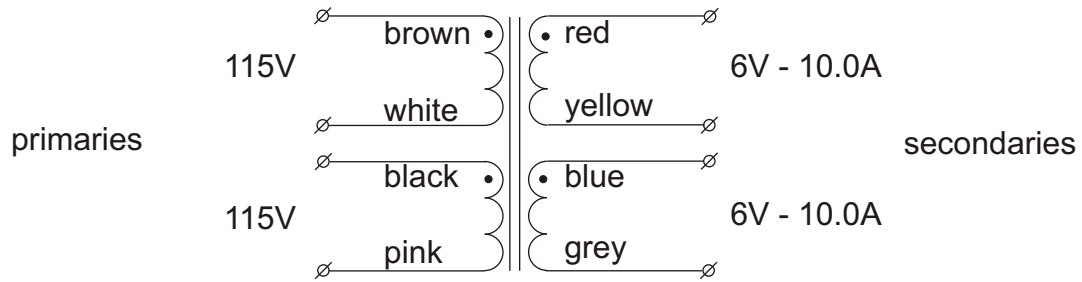

Diameter 91mm  
 Height 49mm  
 Weight 1.4kg  
 Height and weight are measured without mounting materials  
 All leads are solid and approx 200mm long

Supplied mounting materials:  
 1 metal washer Ø70mm  
 2 neoprene washers Ø70mm  
 1 bolt M5x55mm with nut

With KEMA KEUR, ENEC, CE and UL/CSA approvals  
 KEMA certificate 96 2307, UL filenumber E320377.

Time lag fuses to be used.  
 For 230V use: primary: 0.63A, 5x20mm, IEC127, high I<sup>2</sup>t value  
 secondary: none  
 For 115V use: primary: 1.25A, 5x20mm, IEC127, high I<sup>2</sup>t value  
 secondary: none

Type number	primary	secondaries voltage	current
47010	2x115V	2x 6V	10.0A

All voltages are under full ohmic load.  
 Regulation : 8%

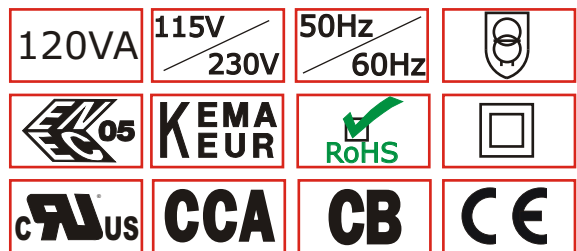

	Industrieweg 14 NL-7161BX NEEDE The Netherlands  P O - B o x 27 NL-7160AA NEEDE The Netherlands Tel.+31 (0)545 283456 Fax+31 (0)545 283457  info@amplimo.nl http://www.amplimo.nl	HB	Oct 2010	<h2>47010</h2> <p>toroidal transformer                  120VA                  for 115V or 230V operation</p>
	© Copyright Amplimo BV			